

UGADI ENTERPRISES



**P O BOX 315
RANDFONTEIN
1760**

**TEL: (011) 693 1185
FAX: (011) 692 4671**

VAT REG: 4370192991
PARTNERS: G.P PRETORIUS (MARKETING), L JOHNSON (ADMIN).

STEEL/PIPES AND FITTINGS



TUBING



ANGLES



SHEETS/PLATES



UNIVERSAL COLUMNS & BEAMS



FLAT BAR



SEAMLESS & FLANGED PIPES

STAINLESS STEEL PIPES/FITTINGS & FLANGES



**312 TP 304 / 304L &
316 / 316L
15 NB TO 300NB
Sch 10 / Sch 40
WELDED / SEAMLESS**



**403WP / 304 / 304L
316 / 316L WX &
WPS B 16.9
15 NB TO 300 NB
Sch 10 / Sch 40
90° ELBOWS
45° ELBOWS
EQUAL TEES
REDUCING TEES
CONCENTRIC REDUCERS
ECCENTRIC REDUCERS
END CAPS**



**ANSI B 16.3 / 316
15 NB TO 300 NB
150 LB BSP
ELBOWS
EQUAL TEES
PLUGS
SOCKETS
REDUCING BUSHES
BARREL NIPPLES**



**ASTM / ASME A/SA
15NB TO 300NB
150LB, 300LB, 600LB
SABS 1123 T600, T1000
T1600, T2500, T4000 BS10
TABLE D, E, F
STANDARD, SLIP-ON,
BLINDS**

HAND RAILS

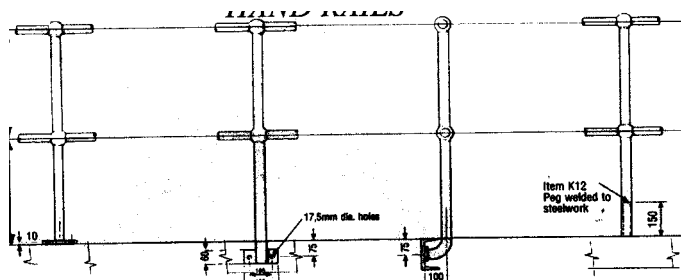

STANTIONS

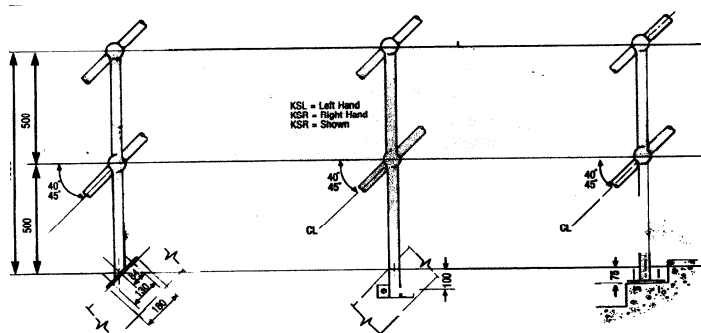

ENDS

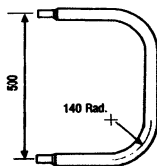
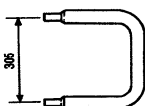
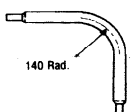

BENDS

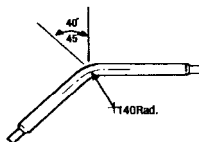
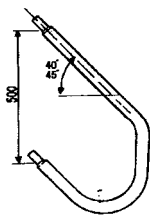

ACCESSORIES

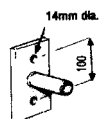

STAIRTREADS/GRATINGS

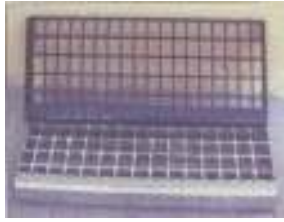

600 X 245
750 X 245
900 X 245



25 X 4.5
30 X 4.5
40 X 4.5

FLANGES/GASKETS



ALL TYPES OF GASKET
GASKET SHEETING
TABLE D/1000/3
FABRIC SEALS
SLIP ON/SOCKET WELD
THREADED



WELD ON FLANGES

BOLTS/NUTS

CUP OVAL/CUP SQUARE NECK BOLTS
RAIL COACH SCREWS
T-HEAD BOLTS (SQUARE/ROUND)
SQUARE HEAD ROUND NECK BOLTS
RAIL DOG SPIKES
HEXAGONHEAD-ROUNDNECK BOLTS
MUSHROOM HEAD-SQUARE NECK
90° COUNTERSUNK-HEAD NIB BOLTS



BEARINGS AND TRANSMISSIONS

BEARINGS

- Roller bearings
- Deep groove bearings
- Self aligning bearings
- Rod ends and spherical bushings
- Taper roller bearings
- Needle roller bearings
- Pillow, plumber blocks and sleeves
- Split bearings
- Slewing rings



TRANSMISSION BELTING

- Vee and wedge belts
- Timing belts
- Variable speed belts
- Poly vee belts

SEALS

- Rotary shaft seals
- Metric & imperial orings
- Hydraulic and pneumatic seals
- Circlips & kits



GEARED MOTORS

- Compact size
- High dynamic applications
- Low noise
- High overload capacity

CHAINS AND POWER TRANSMISSION

- Taperlock bushes
- Poly vee pulleys
- Vee pulleys
- Sprockets
- Universal joints
- Belt pulleys



ABRASIVES

BOND SEGMENTS AND BLOCKS

Plate grinding
Machine knife sharpening
Precision surface grinding
Grinding wheel dressing
Hand dressing
Cylinder head grinding



VERTIFIED BOND WHEELS

Cylindrical grinding
Surface grinding
Tool grinding
Saw sharpening
Crankshaft grinding
Face grinding



RESINOID BOND WHEELS

Cylinder grinding
Slitting wheels
Floor stand fettling
Machine knife sharpening
Face grinding

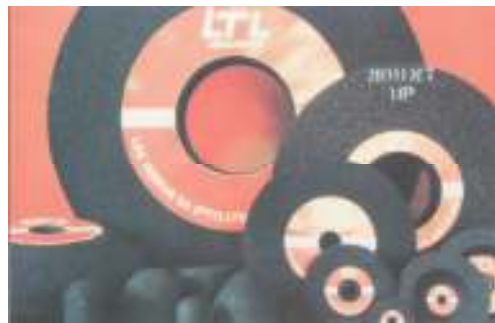

REINFORCED CUTTING WHEELS

Portable grinding
Portable cutting
Die grinding
Portable fettling
Cutting on fixed machines
De-burring



HAND TOOLS



DIAGONAL CUTTERS



PLIERS



LONG NOSE PLIERS



WIRE STRIPPER



GROOVE JOINT PLIERS



HAND GREASE PUMP



TRIMMING KNIFE



CLUB HAMMERS



CHOPPING AXE



TINSNIPS



BOLT CUTTERS



HEAVY DUTY WRENCH



JAW GRIP WRENCH



NAIL PUNCHES



WAD PUNCH



FLAT CHISELS



ADJUSTABLE WRENCHES



ENGINEERING FILES



VENIERS



DRILL SLEEVE/DRIFT SET



TAPE MEASURES



BOW SAWS



POP RIVET GUN



MILLING CUTTERS



SCREWDRIVERS



HEAVY DUTY VICE



DRILL SETS



G - CLAMPS



CRIMPING PLIERS



TAP & DIE SET

BRUSHWARE



WIRE CUP BRUSHES



WIRE WHEELS



**POINT/FLAT DECARBONISING
BRUSHES**



WIRE WHEEL SET



BROOMS/FETHERDUSTERS



WIRE BRUSHES



DIFFERENT SIZE BROOMS AND MOPS



CARPET AND FLOOR CLEANING BRUSHES

AIR TOOLS



IMPACT WRENCH



REVERSIBLE AIR DRILL



CHIPPING HAMMERS



PNEUMATIC GRINDER



AIR HOSE



PRESSURE GAUGE



COUPLINGS



ADAPTORS



SPRAY GUNS



PARAFFIN SPRAY GUN

VALVES

RISING SPINDLE GATE VALVE, NON - RISING SPINDLE GATE VALVE, R.S.V GATE VALVE, KNIFE GATE VALVE, GEARBOX BUTTERFLY VALVE, LEVER OPERATED BUTTERFLY VALVE, COMAP BALANCING VALVE, DOUBLE DOOR WAFER CHEK VALVE, SWING CHECK VALVE, GLOBE VALVE, MUSHROOM CHECK VALVE, PINCH VALVE PHNEUMATIC VALVE, DIAPHRAGM VALVE



WELDING/CUTTING EQUIPMENT



ELECTRODE HOLDERS



EARTH CLAMPS



WELDING KITS



MIG / TIG WELDING



GOUGING TORCHES



WELDING / BRAZING RODS



CUTTING TORCHES



REGULATORS



HOSES



LIGHTERS & FLINTS



NOZZEL CLEANERS



FLASH BACK ARRESTORS



NOZZELS



PORTABLE WELDING & CUTTING SET

HARDWARE



GARDEN FORK



SQ MOUTH SHOVEL



GARDEN SPADE



PICKS



GARDEN RAKES



CONCRETE/FLAT WHEEL BARROWS



PADLOCKS



BARRIER TAPE



SISAL TWINE



SKI-ROPE



SPRAY/MARKING PAINT



LUBRICANTS



PLUM BOPS



SANDING PAPER



INSULATION TAPE



PAINT BRUSHES



ALL TYPES OF PAINT



WIRE BRUSHES

CLEANING PRODUCTS



HAND SOAPS
HAND CLEANER
BLEACH
DISINFECTANTS
SCOURING POWDER
DEO BLOCKS
DETERGENTS
TOILET SOAPS
AIR FRESHENER
BARRIER CREAM
POLISH

KITCHEN CLOTHS
TOILET PAPER
KIMWIPE ROLLS
COTTON WOOL
STEEL WOOL
CLEANING CLOTHS
KIMWIPES



ENGIN CLEANERS
DEGREASERS
LAUNDRY DETERGENTS
JEYES FLUID
DOOM
WINDOW CLEANERS



CLEANING RAGS
MUTTON CLOTH



LIFTING EQUIPMENT

STEEL WIRE ROPES & SLINGS

- DIFFERENT SIZES AND LENGTHS



CHAIN & CHAIN SLINGS

-HERC ALLOY CHAIN IS MANUFACTURED IN SOUTH AFRICA FROM LOCAL STEEL TO SABS 189/1993 SPECIFICATION. CHAIN SIZES ARE FROM 6MM TO 32MM EMBOSSED "MCK" AND "HAB" FOR IDENTIFICATION.

-DIFFERENT TYPES OF SLINGS (SINGLE LEG, DOUBLE LEG, TRIPLE AND QUADRUPLE LEG)



SHACKLES, HOOKS & WIRE ROPE CLAMPS

- TESTED LARGE "D" SHACKLES

- CROSBY AND BEEST CLAMPS

- LIFTING HOOKS (EYE TYPE, SWIVEL, LATCHLOC AND CLEVIS TYPE)



LIFTING EQUIPMENT

TITAN CHAIN BLOCKS & LEVERHOISTS

- 1 TON TO 10 TON
- 3m TO 12m LIFTS
- BREAKING LOAD 5 TO 1
- CHAINS ELECTRO GALVANIZED
- ALL PARTS AVAILABLE
- 6 MONTHS SERVICE INTERVALS



PLAIN CRAWLS & GEARED CRAWLS



SOCKETS, TURN BUCLES AND RIGGING SCREWS

GALVANIZED OPEN AND CLOSED SOCKETS RANGES FROM 8mm TO 95mm APPLICATIONS PENDANT ROPES FOR DRAGLINES, SUSPENSION ROPES. TESTED AND UNTESTED TURNBUCLES, HOOK & EYE / YE & YE SIZES FROM 8mm TO 26mm



THIMBLES

TO PROTECT YOUR STEEL WIRE SLINGS USE THIMBLES (HEART SHAPE, REEVING AND SOLIDS)



WEBBING SLING & TIE DOWN STRAPS



FALL ARREST



KERMANTEL STATIC ROPE



ROPE GRAB



RETRACTABLE WEBBING LIFE LINE



RESCUE WINCH



TRIPOD



UNIVERSAL RESCUE DEVICE



DESCENDER



ASCENDER

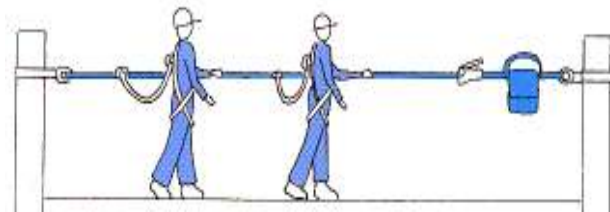

WEBBING MOBILE LIFE LINE



RETRACTABLE LANYARD



RATCHET PULLER



NGK GRIP



FALL ARRESTOR

MEDICAL EQUIPMENT



STRETCHER



SPINE BOARD



MEDICAL BAG



MEDICAL BOX



CAR MEDICAL KIT

FIRE PROTECTION



ELECTRICAL SUIT



FIREMANS SUIT & BOOTS



FIREMANS GLOVE



RED HEAT KEVLER GLOVE



FIBERGLASS FIRE EXTINGUISHER BOX



LIFE BOY IN FIBERGLASS BOX

SAFETY HARNESS



MINERS BELT



FUL BODY HARNESS WITH BACK STRAPP



LINESMAN BELT



SIT BELT HARNESS



RESCUE VICTIM SIT HARNESS



FULL BODY HARNESS 1.8 LANYARD



FULL BODY HARNESS/DUBBLE LANYARD/ SHOCK ABSORBER



FULL BODY HARNESS WITH SHOCK ABSORBER

PROTECTIVE WEAR

CONTI SUITS/BOILER SUITS

- (UG 2601) - ROYAL BLUE CONTI SUITS
- (UG 2602) - ROYAL BLUE BOILER SUITS
- (UG 2603) - ASSORTED COLOURS CONTI SUITS
- (UG 2604) - ASSORTED COLOURS BOILER SUITS
- (UG 2605) - ACID RESISTANT CONTI SUITS
- (UG 2606) - FLAME RETARDENT CONTI SUITS
- (UG 2607) - LADIES OVERALLS
- (UG 2608) - ASSORTED COLOURS DUST COATS
- (UG 2609) - DENIM CONTI SUIT



RAIN WEAR

- (UG 2501) - YELLOW PVC RAIN SUITS
- (UG 2502) - NAVY BLUE RAIN SUITS
- (UG 2503) - NAVY RUBBERIZED RAIN SUIT
- (UG 2504) - YELLOW PVC CHEMICAL SPLASH SUI

ROMOTIONAL CLOTHING

- (UG 2201) - GOLF SHIRTS (PRINTING)
- (UG 2202) - T-SHIRTS (PRINTING)
- (UG 2203) - GOLF CAPS (PRINTING)



FREEZER WEAR

- (UG 2300) 100% WATERPROOF 2PCE FREEZER SUIT
- (UG 2301) 100% WATERPROOF 1PCE FREEZER SUIT

EYE/EAR/HEAD PROTECTION



U101 - LASER SPEC



U102 - LASER SPORT



U103 - VIPER



U104 - ALROUND



U105 - LASER ULTRA



U106 - LASER GREEN



U107 - ULTRA VISION



U108 - DUST GOGGEL



U109 - ELVEX 200



U110 - ELVEX 100



U111 - LIFT FRONT



U112 - GAUZE



U113 - VISOR



U114 - WELDING



U115 - AUTO DARK



U116 - FOAM EAR



U117 - RE-USABLE



U118 - SHEPPARD



U119 - RACAL



U120 - PERFLEX



U121 - COMFORT



U122 - FOLDABLE



U123 - SNAP ON



U124 - SAFETY CAP



U125 - ALUMINIUM CAP ATTACHMENT



U126 - WELDING CURTAIN

HAND PROTECTION



**CHROME LEATHER
(UGA 01)**



**REINFORCED CANDY STRIPE
(UGA 02)**



**CANDY STRIPE
(UGA 03)**



**RED HEAT KEVLER
(UGA 04)**



**GREEN WELDING
(UGA 05)**



**LINED LEATHER
(UGA 06)**



**NAPPA FULL LEATHER
(UGA 07)**



**GOATSKIN
(UGA 08)**



**MEDIUM WEIGHT
(UGA 09)**



**HEAVY WEIGHT
(UGA 10)**



**MEDIUM WEIGHT ELBOW
(UGA 11)**



**ROUGH GRIP/TOUGH GRIP
(UGA 12)**

HAND PROTECTION



ELECTRICIAN GLOVE
(UGA 13)



CHEMICAL RESISTANT
(UGA 14)



GREEN NITRILE
(UGA 15)



POLKA DOT
(UGA 16)



BLACK NEOPRENE
(UGA 17)



CRISS CROSS
(UGA 18)



CHAIN MESH
(UGA 19)



CRAYFISH
(UGA 20)



ROUGH GRIP
(UGA 21)



ORANGE PVC
(UGA 22)



COTKNIT LINER
(UGA 23)



TOWELLINGGLOVE
(UGA 24)

RESPIRATORY PROTECTION



UG 201/FF1/FF2 MASK



UG 202 /FF1/FF2 MASK WITH VALVE



UG 203 MASK WITH VALVE - WELDING



UG 204 HALF MASK



UG 205 S/ FILTER MASK



UG 206 F/F MASK



UG 207 TURBO VISOR



UG 208 FULL FACE MASK



DW/A2



DW/ARFK1

UG 209 CARTRIDGES (DIFFERENT APPLICATIONS)



UG 210 PVC HOOD RESPIRATOR/FILTERS



UG 211 AIR SUPPLIED SANDBLASTING HOOD

SAFETY FOOTWEAR



5001 BOVA



5002 BOVA



5003 BOVA



8017 LEMAITRE



8005 LEMAITRE



9650 BROGUE



8505 LADIES



9014 LEMAITRE



4421 FRAM



2047 INYATHI



9015 MAGNUM



4446 CHUKKA



9025 MAGNUM



4563 INYATHI



2355 BELL



9001 MENS / LADIES
GUM BOOTS

SAFETY FOOTWEAR



REBEL CHUKKA



NOVA CHUKKA



EXEC CHUKKA



ZEUS CHUKKA



THOR CHUKKA



STRIKER CHUKKA



SNAPPY CHUKKA



MOCASSIN



COMFO SHOE



CHUKKA BOOT



SAFETY BOOT



SAFETY BOOT / WELDING